

Turbo CB Hydraulic Rakes & Auto Rakes

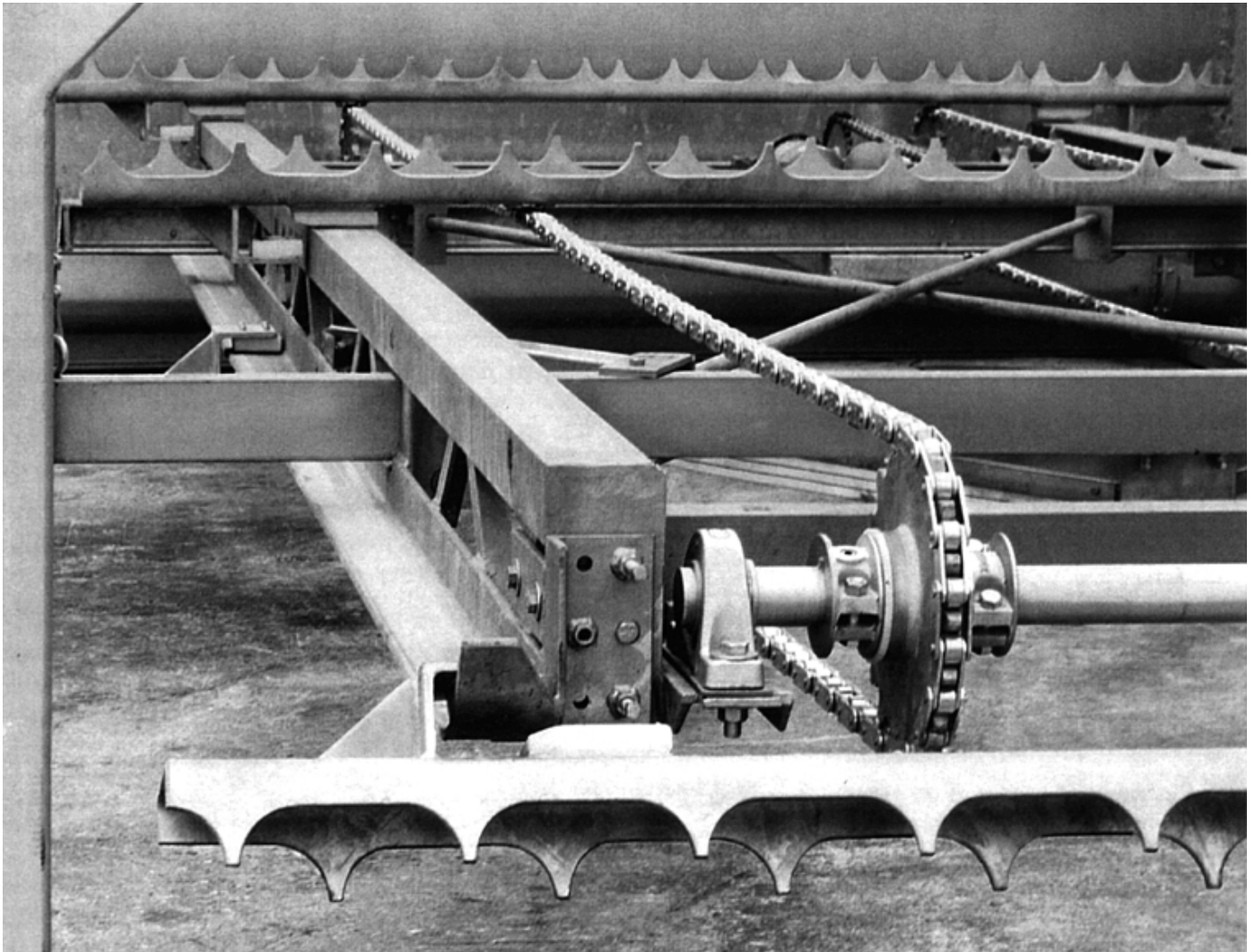

**Automatic Rake Assembly without
Optional Bin Structure and 180° Return Bends**

CB Hydraulic & Auto Rakes

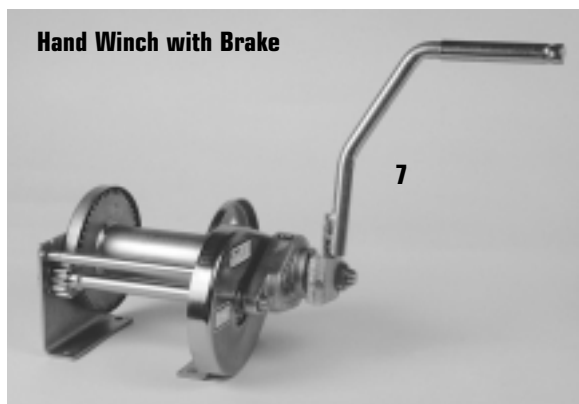
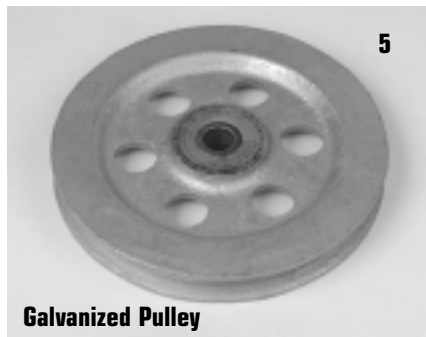
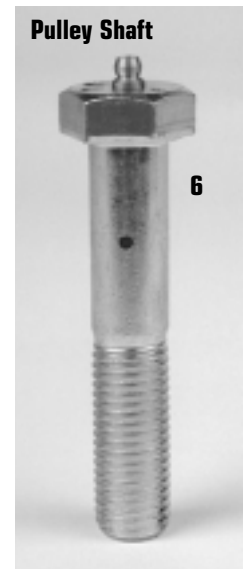
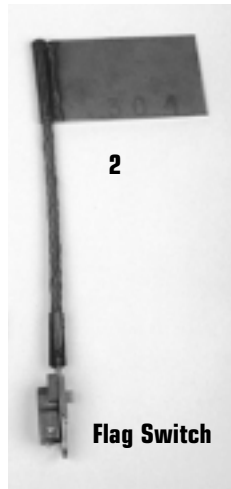

CB Hydraulic & Auto Rakes

Item	Turbo Part No.	Description	Applications (Models)
1, 2	035-1900-19	Limit Switch Furnas 54LA19	CB & Auto Rakes
1, 2	216-1209-31	Arm Limit Switch (Flag)	CB Rakes
1	035-1900-00	Limit Switch Furnas 54LA51	Auto Rakes
3	019-0100-01	Sensor Cap Proximity	CB & Auto Rakes
4	075-1510-00	Hydraulic Power Unit MPTAC-100	CB & Auto Rakes
5	015-0002-01	Pulley Galv Bronzed Bushed 6"	CB Rakes
5	015-0002-00	Pulley Galv Bronzed Bushed 8"	CB & Auto Rakes
6	216-1209-30	Pulley Shaft Greasable	CB & Auto Rakes
7	032-3100-02	2000# Hand Winch	CB Rakes
7	032-3100-04	4000# Hand Winch	Auto Rakes
8	031-3080-13	Sprocket 13th 80SDS13H	CB Rakes
9	015-1300-24	Bushing 1-1/2" SDS	CB Rakes

CB Hydraulic & Auto Rakes

**10 – Idler Sprocket
18T CB; 38T Auto**



**11 – Drive Sprocket
18T CB; 38T Auto**



Sprocket

14

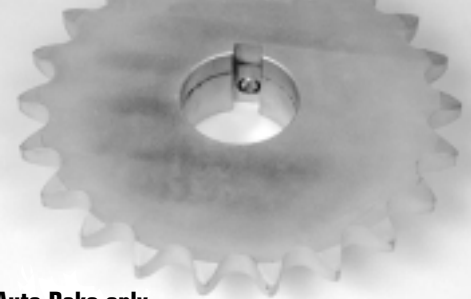

Auto Rake only

**13 – Bushing
2-3/16" CB**

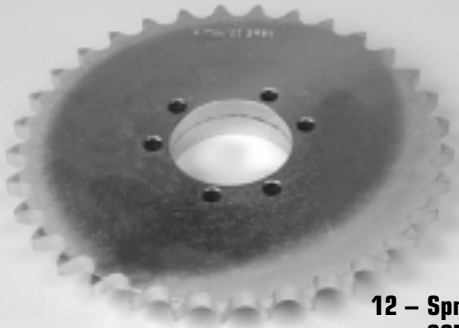

**12 – Sprocket
33T CB; 52T Auto**



**Pillow Block
Bearing**

17



15 – Plastic Drive Sprocket



16 – Plastic Idler Sprocket

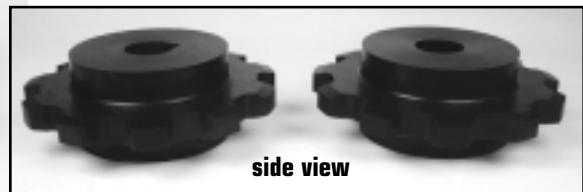

side view

CB Hydraulic & Auto Rakes

Item	Turbo Part No.	Description	Applications (Models)
10	031-6160-1835	Idler Sprocket 18th 2082	CB Rakes
10	031-6160-3855	Idler Sprocket 38th 2082	Auto Rakes
11	031-7160-1835	Drive Sprocket 18th 2082 with 2-3/16" Bushing	CB Rakes
11	031-7160-3855	Drive Sprocket 38th 2082	Auto Rakes
12	031-3080-33	Sprocket 33th 80SF33H	CB Rakes
12	031-3100-52	52th Sprocket with Bushing	Auto Rakes
13	015-1600-35	Bushing 2-3/16" SF	CB Rakes
13	015-1300-22	Bushing 1-3/8" SDS	CB Rakes
14	031-1100-2240	Sprocket 2-1/2" Bore ASA100 22th	Auto Rakes
14	031-1080-1436	Sprocket 2-1/4" Bore ASA	Auto Rakes
14	031-2080-8047	Sprocket 2-15/16" ASA80	Auto Rakes
15	031-8082-00	Drive Sprocket Poly Style NH82	CB Rakes
16	031-8082-10	Idler Sprocket Poly Style NH82	CB Rakes
17	029-0001-18	Pillow Block Bearing 2-3/16"	CB Rakes
17	029-0001-56	Pillow Block Bearing 3-7/16"	Auto Rakes

CB Hydraulic & Auto Rakes

Split Locking Collar



18

22 – Roller Chain

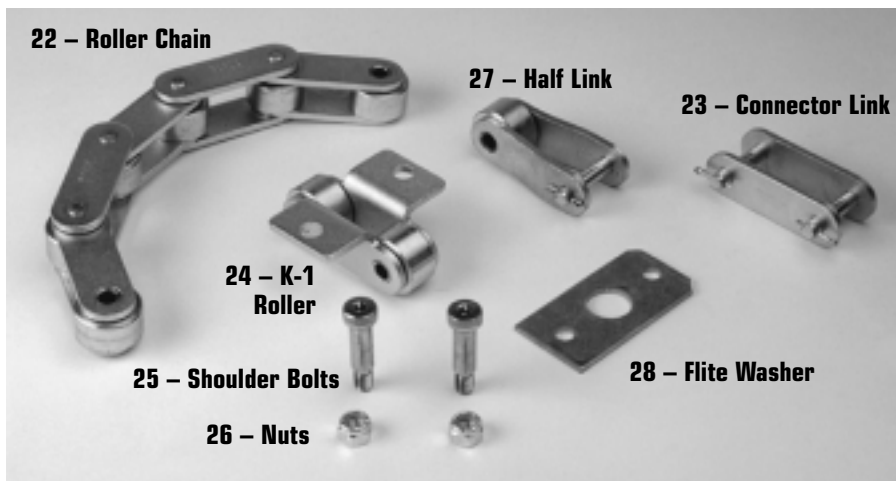

27 – Half Link

23 – Connector Link

24 – K-1
Roller

25 – Shoulder Bolts

26 – Nuts

28 – Flite Washer

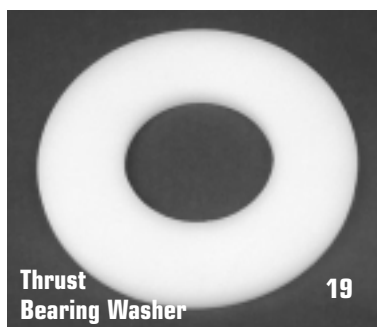

Thrust
Bearing Washer

19

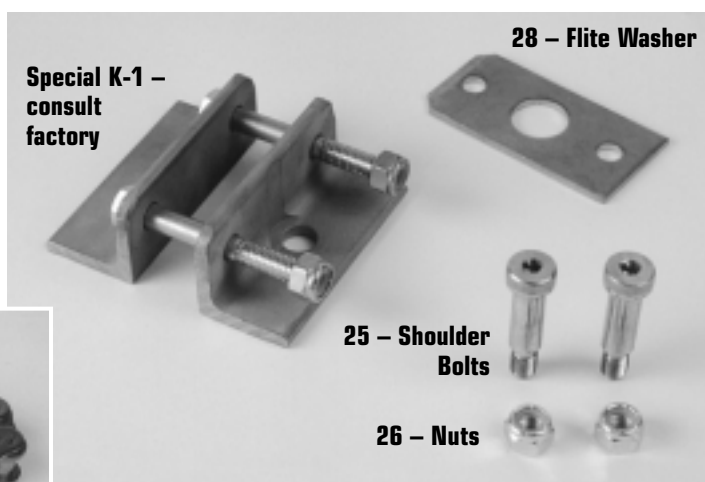

28 – Flite Washer

Special K-1 –
consult
factory

25 – Shoulder
Bolts

26 – Nuts



21

20

Stainless Steel ASA Chain



TURBO
800-788-4301

CB Hydraulic & Auto Rakes

Item	Turbo Part No.	Description	Applications (Models)
18	029-0102-35	Steel Locking Collar 2-3/16"	CB Rakes
18	029-0102-55	Steel Locking Collar 3-7/16"	Auto Rakes
19	216-0003-35	Thrust Bearing Washer 2-3/16"	CB Rakes
19	204-0003-03	Thrust Bearing Washer 3-7/16"	Auto Rakes
20	032-0504-08	ASA80 Roller Chain	CB Rakes
21	032-0504-09	ASA80 Master Link	CB Rakes
22	032-0701-10	C2082 Roller Chain Zinc Plated	CB & Auto Rakes
22	032-1049-11	Roller Chain C2082 Stainless Steel	CB & Auto Rakes
23	032-0803-00	C2082 Connecting Links Zinc Plated	CB & Auto Rakes
23	032-0601-11	Connecting Links C2082 Stainless Steel	CB & Auto Rakes
24	032-1018-10	C2082 K-1 Roller Attachments Zinc Plated	CB & Auto Rakes
24	032-1048-10	K-1 Roller Attachments C2082 Stainless Steel	CB & Auto Rakes
24	202-1000-10	New Style K-1 Stainless Steel	Auto Rakes
25	003-5820-11	Shoulder Bolts 3/8" x 1"	CB & Auto Rakes
26	001-0601-20	5/16"-18 Locknuts	CB & Auto Rakes
27	032-0801-10	Half Links C2082 Zinc Plated	CB & Auto Rakes
27	032-0801-11	Half Links C2082 Stainless Steel	CB & Auto Rakes
28	216-2512-0202	Rake Flite Washer	CB & Auto Rakes

CB Hydraulic & Auto Rakes

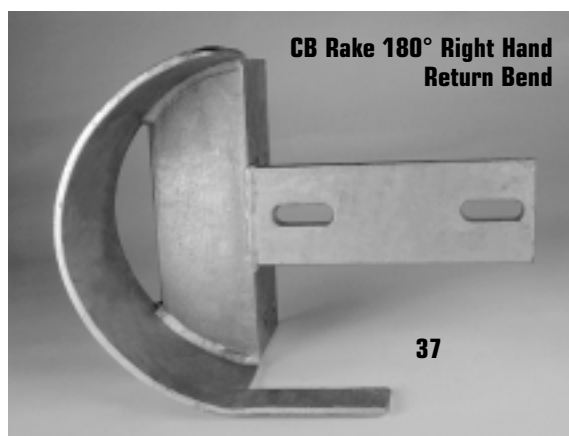
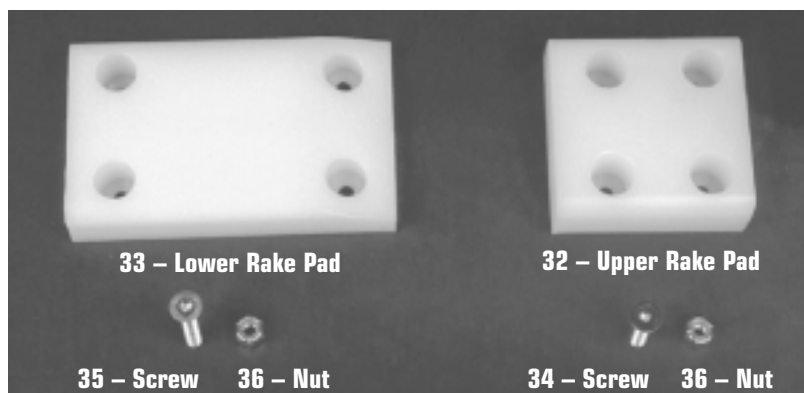

CB Hydraulic & Auto Rakes

Item	Turbo Part No.	Description	Applications (Models)
29	032-1082-00	Poly Style Roller Chain NH82	CB & Auto Rakes
30	032-1082-10	Poly Style K-1 Attachment NH82	CB & Auto Rakes
31	034-1800-06	2 HP Gear Motor Dual Voltage	CB Rakes
31	034-1800-13	7-1/2 HP Gear Motor Dual Voltage	Auto Rakes
31	034-1800-14	0.5 HP Gear Motor Dual Voltage	Auto Rakes (Hoist)
31	034-1800-16	3 HP Gear Motor Dual Voltage	CB75, CB87
32	069-1100-01	Upper Rake Pad 3" x 3"	CB & Auto Rakes
33	069-1100-00	Lower Rake Pad 3" x 5"	CB & Auto Rakes
34	003-2917-12	1/4"-20 x 1" Screw for Upper Pad	CB & Auto Rakes
35	003-2917-14	1/4"-20 x 1-1/2" Screw for Lower Pad	CB & Auto Rakes
36	001-0601-17	1/4"-20 Locknuts for Upper & Lower Pads	CB & Auto Rakes
37	216-1209-9001	Return Bend 180° Left Hand	CB Rakes
37	216-1209-9002	Return Bend 180° Right Hand	CB Rakes
38	202-1008-2201	Return Bend 180° Left Hand	Auto Rakes
38	202-1008-2202	Return Bend 180° Right Hand	Auto Rakes

CB Hydraulic & Auto Rakes

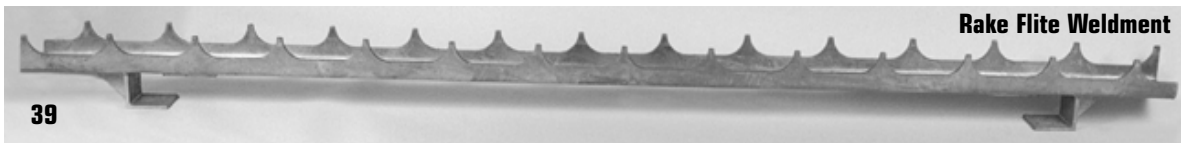

Counterweight

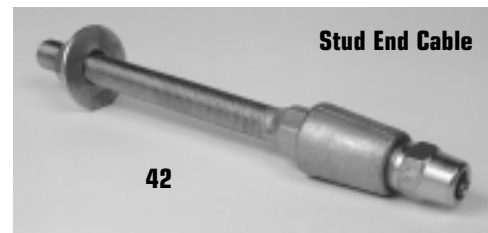
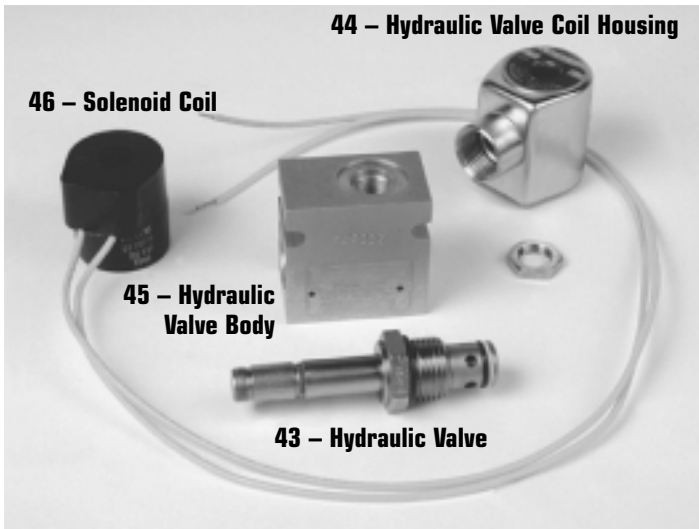

CB Hydraulic & Auto Rakes

Item	Turbo Part No.	Description	Applications (Models)
39	216-1209-0226	Rake Flite Weldment 10' (A)	CB Rakes
39	216-1209-0227	Rake Flite Weldment 10' (B)	CB Rakes
39	216-1209-0228	Rake Flite Weldment 10' (C)	CB Rakes
39	216-1209-0229	Rake Flite Weldment 10' (D)	CB Rakes
39	216-2512-0234	Rake Flite Weldment 12'-6" (A)	CB Rakes
39	216-2512-0235	Rake Flite Weldment 12'-6" (B)	CB Rakes
39	216-2512-0236	Rake Flite Weldment 12'-6" (C)	CB Rakes
39	216-2512-0237	Rake Flite Weldment 12'-6" (D)	CB Rakes
39	216-2514-0234	Rake Flite Poly Weldment 14'-6" (A)	CB87
39	216-2514-0235	Rake Flite Poly Weldment 14'-6" (B)	CB87
39	216-2514-0236	Rake Flite Poly Weldment 14'-6" (C)	CB87
39	216-2514-0237	Rake Flite Poly Weldment 14'-6" (D)	CB87
39	202-2000-33	Rake Flite Weldment 15' Wide Rake (A)	Auto Rakes
39	202-2000-34	Rake Flite Weldment 15' Wide Rake (B)	Auto Rakes
39	202-2000-35	Rake Flite Weldment 15' Wide Rake (C)	Auto Rakes
39	202-2000-36	Rake Flite Weldment 15' Wide Rake (D)	Auto Rakes
39	202-2000-25	Rake Flite Weldment 20' Wide Rake (A)	Auto Rakes
39	202-2000-26	Rake Flite Weldment 20' Wide Rake (B)	Auto Rakes
39	202-2000-27	Rake Flite Weldment 20' Wide Rake (C)	Auto Rakes
39	202-2000-28	Rake Flite Weldment 20' Wide Rake (D)	Auto Rakes
40	216-1209-36	Electrical Counterweight	CB & Auto Rakes
41	202-1003-2006	Adjustable Bearing Stop	Auto Rake
42	051-0501-04	Stud End Fitting for 1/2" Cable	CB & Auto Rakes
43	075-1400-02	Hyd Valve Sol Modular Control	CB Rakes
44	075-1400-03	Hyd Valve Coil Housing Modular Control	CB Rakes
45	075-1400-04	Hyd Valve Sol Body Modular Control	CB Rakes
46	035-0501-48	Coil Sol 110 Volt Modular Control	CB Rakes



CB Hydraulic & Auto Rakes

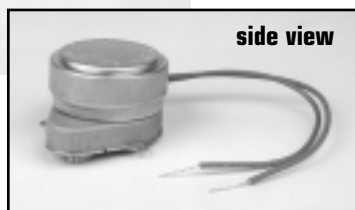
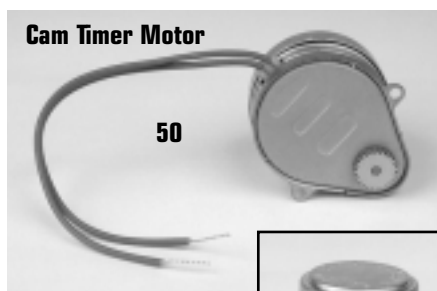
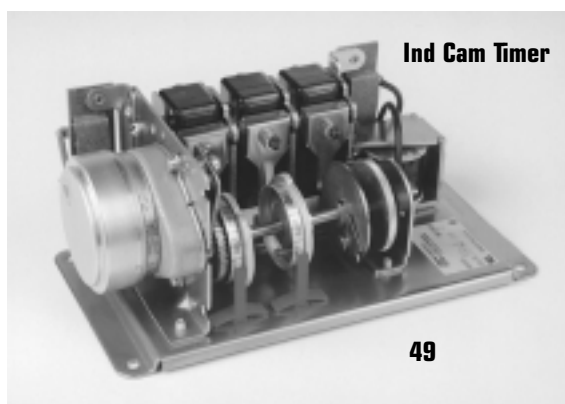
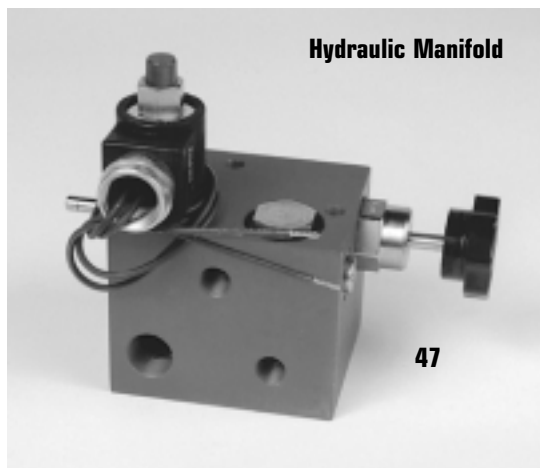

CB Hydraulic & Auto Rakes

Item	Turbo Part No.	Description	Applications (Models)
47	075-1209-01	Hydraulic Manifold (Red)	CB & Auto Rakes
48	075-0144-17	Hydraulic Cylinder 2-1/2" (Door)	CB & Auto Rakes
48	075-0154-72	Hydraulic Cylinder 3-1/4"	CB Rakes
49	021-0308-04	Timer Ind RC4 2 Cam with Motor	CB & Auto Rakes
49	021-0300-03	Ind Timer 2 Cam Less Motor	CB & Auto Rakes
50	021-0400-12	Timer Motor 12 RPH 120 Volt (Hoist)	CB Rakes
50	021-0400-00	Timer Motor 4 RPH 120 Volt (Forward & Reverse)	CB Rakes
50	021-0400-03	Timer Motor 1 RPM 120 Volt	Auto Rakes
51	021-0400-02	Replacement Micro Switch for Cam Timer	CB & Auto Rakes
52	See note 1	Gear Rack	CB & Auto Rakes
53	035-0103-0701	Relay 4 Pole 120 Volt	CB & Auto Rakes
54	035-0820-009	Contactors 3 Pole 9 Amp 120 Volt	CB & Auto Rakes

Note 1. Turbo part number depends on machine's serial & model number.

CB Hydraulic & Auto Rakes

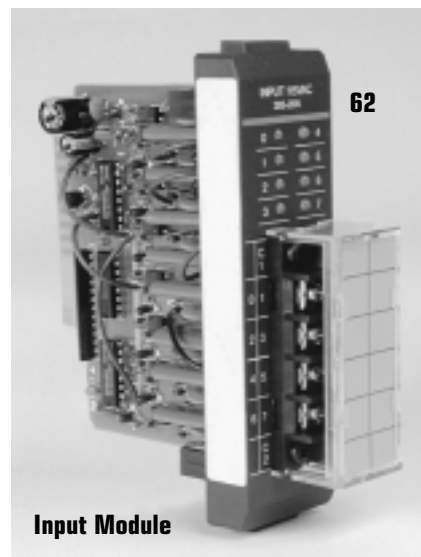
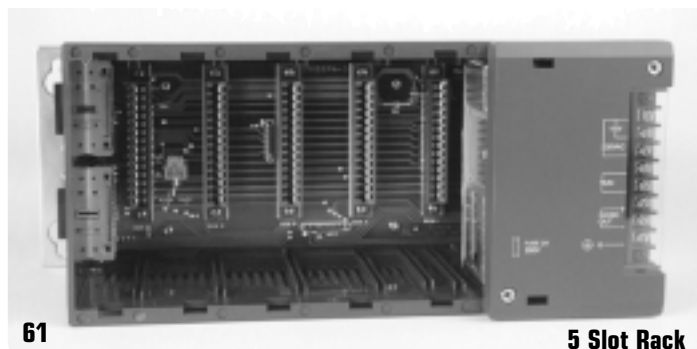

CB Hydraulic & Auto Rakes

Item	Turbo Part No.	Description	Applications (Models)
55	037-0701-02	10 Amp Circuit Breaker	CB & Auto Rakes
56	035-0208-00	Relay Load Detector 230 Volt	CB & Auto Rakes
56	035-0208-01	Relay Load Detector 460 Volt	CB & Auto Rakes
57	035-0208-10	Autogard Power Monitor 460 Volt	CB & Auto Rakes
57	035-0208-11	Autogard Power Monitor 230 Volt	CB & Auto Rakes
58	080-0000-30	Programmer Controller (CPU)	CB & Auto Rakes
59	080-0000-31	Hand Held Programmer	CB & Auto Rakes
60	080-0000-43	Cable CPU to Hand Held Programmer	CB & Auto Rakes
61	080-0000-32	5 Slot Rack 115/230 Volt	CB & Auto Rakes
62	080-0000-34	8 Point Input Module 115 Volt	CB & Auto Rakes

CB Hydraulic & Auto Rakes

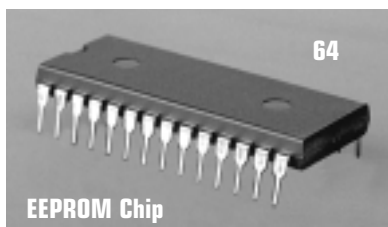
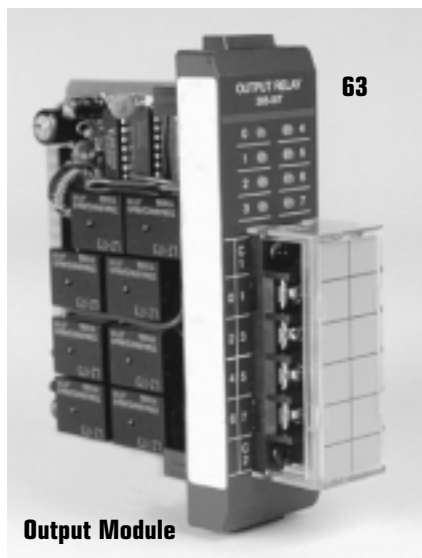

CB Hydraulic & Auto Rakes

Item	Turbo Part No.	Description	Applications (Models)
63	080-0000-36	8 Point Output Module 115/230 Volt	CB & Auto Rakes
64	080-0000-39	EEPROM Chip for CPU	CB & Auto Rakes
65	080-0000-27	Replacement Battery for CPU	CB & Auto Rakes

Turbo Tech-Man Sez



Check rake
for squareness
every three
months.



TURBO
800-788-4301

Reach Turbo at:

phone **800-788-4301**
 fax **800-380-3081**
 e-mail **turbo1@iglobal.net**
 internet **http://www.turboice.com**

Turbo Tech-Man Sez

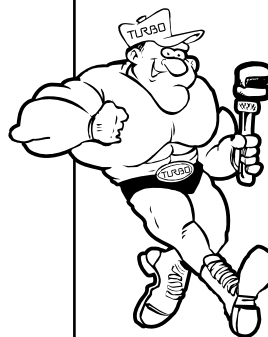

Don't get
caught on the
Fourth of July
without the
parts you need.



CB Hydraulic Rakes

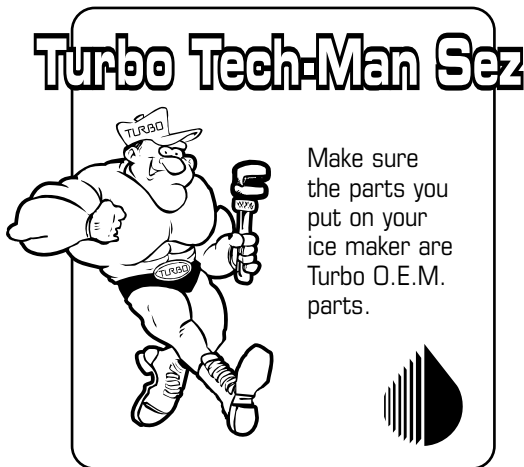

Item	Turbo Part No.	Description
1	035-1900-19	Switch Limit Furnas 54LA19
2	215-1209-31	Arm Limit Switch (Flag)
3	216-0008-0201	Arm Limit Switch 3/16" Dia 15" Long
4	035-1900-1901	Switch Limit Arm Actuator Furnas 54LAP644
5	019-0100-01	Sensor Cap Prox N/O or N/C 20-250 AC
6	075-1510-00	Hyd Power Unit MPTAC100B15
7	015-0002-01	Pulley Galv 1 GR Bronze Bushed 6"
8	032-3100-02	Winch Hand 2000# with Brake
9	031-3080-13	Sprocket 13th 80SDS13H
10	031-3080-33	Sprocket 80SF33H 33th
11	031-6160-1835	Sprocket Idler 2082C18H
12	031-7160-1835	Sprocket Drive 2082 with 2-3/16" Bushing
13	029-0001-18	Pillow Block 2-3/16" Bore
14	029-0102-35	Collar Steel Locking 2-3/16" (Split)
15	216-0003-35	Thrust Bearing Washer 2-3/16"
16	015-1300-24	Bushing 1-1/2" Type SDS
17	015-1600-35	Bushing 2-3/16" Type SF
18	032-0504-09	Chain Link ASA80 Stainless Steel
19	032-0504-08	Chain Roller ASA80 Stainless Steel
20	032-0701-10	Roller Chain C2082 Zinc Plated
21	032-0803-00	Conn Links C-2082 Zinc Plated
22	032-1018-10	K-1 Roller Attachments C2082 Zinc Plated
23	032-0801-10	Half Links C2082 Zinc Plated
24	003-5820-11	Shoulder Bolts 3/8" x 1" Zinc Plated for K-1's
25	001-0601-20	Locknuts 5/16"-20 for K-1's
26	034-1800-06	Gear Motor 2HP 230/460/3/60
27	034-1800-16	3 HP Gear Motor (CB75, CB87)
28	069-1100-01	Upper Rake Pads 3" x 3"
29	069-1100-00	Lower Rake Pads 3" x 5"
30	003-2917-12	Screw 1/4"-20 x 1" for Upper Pads
31	003-2917-14	Screw 1/4"-20 x 1-1/2" for Lower Pads
32	001-0601-17	Locknuts 1/4"-20 for Upper & Lower Pads
33	216-2512-0202	Rake Flite Washer
34	216-1209-9001	Return Bend Weldment 180 Degree LH
35	216-1209-9002	Return Bend Weldment 180 Degree RH
36	216-1209-0226	Rake Flite Weldment (A) 10' CB
37	216-1209-0227	Rake Flite Weldment (B) 10' CB
38	216-1209-0228	Rake Flite Weldment (C) 10' CB
39	216-1209-0229	Rake Flite Weldment (D) 10' CB
40	216-1209-36	Electrical Counterweight
41	216-1209-0804	Top Beam Pulley Assembly
42	051-0202-06	Wire Cable Stranded Galv 1/4"
43	216-1209-021801	Rake Drive Shaft CB Rake
44	216-1209-021802	Rake Idler Shaft CB Rake
45	216-1209-021803	Covering Drive Shaft CB Rake 2-1/2" PVC
46	216-1209-021804	Covering Idler Shaft CB Rake 2-1/2" PVC

Control Panel with Mechanical Timers

Item	Turbo Part No.	Description
47	021-0308-04	Timer Ind RC4 2 Cam with #18 Gear Rack 120 Volt
48	021-0300-03	Ind Timer 2 Cam Less Motor
49	021-0400-12	Timer Motor Ind 12 RPH 120 Volt (Hoist)
50	021-0400-00	Timer Motor Ind 4 RPH 120 Volt (Forward & Reverse)
51	021-0400-02	Replacement Micro Switch for Timer
52	035-0103-0701	Relay 4 Pole 3 N/O 1N/C 120 Volt S&S
53	035-0820-009	Contactors 3 Pole 9 Amp 120 Volt S&S
54	035-0208-00	Relay Load Detector Sq D 230 Volt
55	035-0208-10	Autogard Power Monitor 460 Volt
56	035-0208-11	Autogard Power Monitor 230 Volt
57	035-8001-02	Soft Start 11 Amp 2 HP 230/460 Volt 7.5 HP
58	021-0608-00	Transfer Current 600V 50:5 Sq D
59	035-0203-01	Relay On Delay 1.0-10 Sec 120 V P&B
60	035-0204-00	Relay Base 8 Pin for Above Relay
61	035-0303-09	Push Button Mushroom Red GE
62	032-0701-02	10 Amp Circuit Breaker
63	019-0401-01	Control Temp Penn A19BAC-1
64	035-0204-01	Relay Base 11 Pin
65	038-1103-65	Switch Safety Sq D HU361 600 Volt

Control Panel with CPU

Item	Turbo Part No.	Description
66	080-0000-30	Prog Control CPU 3.7K Ram
67	080-0000-31	Prog Control Hand Held
68	080-0000-32	Prog Control 5 Slot Rack 115/230 Volt
69	080-0000-34	Prog Control 8 Point Input Module 115 Volt
70	080-0000-36	Prog Control 8 Point Output Module 115/230 Volt
71	080-0000-39	Prog Control EEPROM Chip for CPU
72	080-0000-27	Replacement Battery for CPU
73	080-0000-43	Cable CPU to Hand Held Programmer
74	036-0005-30	Heater Strip 150W 120 Volt 75 Long Chromlox

Hydraulic Door Cylinder Assembly

Item	Turbo Part No.	Description
75	012-0604-04	Valve Relief Hyd 1/4" NPTF 2000 PSI
76	075-0144-17	Hyd Cylinder 2-1/2"
77	216-1209-6302	Hyd Hose Assembly 1/4" x 14-1/2' Long
78	216-1209-6307	Hose Assembly Rake 1/2" x 22' Long

Hydraulic Kit

Item	Turbo Part No.	Description
79	015-0002-00	Pulley Galv Bronzed Bushed 8"
80	216-1209-30	Pulley Shaft Greaseable
81	216-1209-6301	Hyd Hose Assy 18' x 1/2"
82	216-1209-6308	Hyd Hose Assy 10' x 1/2"
83	075-0201-02	Hyd Gauge 0-3000 PSIG
84	075-1209-01	Hyd Manifold CB Rakes (Red)
85	075-0154-72	Hyd Cylinder 3-1/4"
86	051-0501-04	Wire Stud End 1/2" Cable 3/4" Thread
87	051-0202-11	Wire Cable Stranded Galv 1/2"
88	075-1400-02	Hyd Valve Sol Modular Control SV1
89	075-1400-03	Hyd Valve Sol Coil Housing Modular Control
90	075-1400-04	Hyd Valve Sol Body Modular Control
91	035-0501-48	Coil Sol 110 Volt Modular Control
92	075-1510-00	Hyd Power Unit MPTAC-100B15
93	216-1209-6300	Hyd Hose Assy 10' x 1/4"
94	216-1209-6308	Hyd Hose Assy 10' x 1/2"

CB Rake with Plastic & Stainless Steel Chain

Item	Turbo Part No.	Description
95	031-8082-00	Sprocket Poly Style C NH82 Drive 2-3/16"
96	031-8082-10	Sprocket Poly Style C NH82 Idler 2-3/16"
97	032-1082-00	Chain Poly Chain NH82
98	032-1082-10	Chain Poly Attachment NH82-K1 with LK Pin
99	216-1209-0226	Rake Flite Weldment (A) CB Poly 10'
100	216-1209-0227	Rake Flite Weldment (B) CB Poly 10'
101	216-1209-0228	Rake Flite Weldment (C) CB Poly 10'
102	216-1209-0229	Rake Flite Weldment (D) CB Poly 10'
103	216-2512-0234	Rake Flite Weldment (A) 12'-6"
104	216-2512-0235	Rake Flite Weldment (B) 12'-6"
105	216-2512-0236	Rake Flite Weldment (C) 12'-6"
106	216-2512-0237	Rake Flite Weldment (D) 12'-6"
107	216-2514-0234	Rake Flite Weldment (A) CB87 Poly
108	216-2514-0235	Rake Flite Weldment (B) CB87 Poly
109	216-2514-0236	Rake Flite Weldment (C) CB87 Poly
110	216-2514-0237	Rake Flite Weldment (D) CB87 Poly
111	032-0801-11	Half Links Stainless Steel C2082
112	032-1049-11	Stainless Steel Roller Chain C2082
113	032-0601-11	Stainless Steel Connecting Links C2082
114	032-1048-10	K-1 Roller Attachments Stainless Steel C2082

CB Hydraulic Rakes

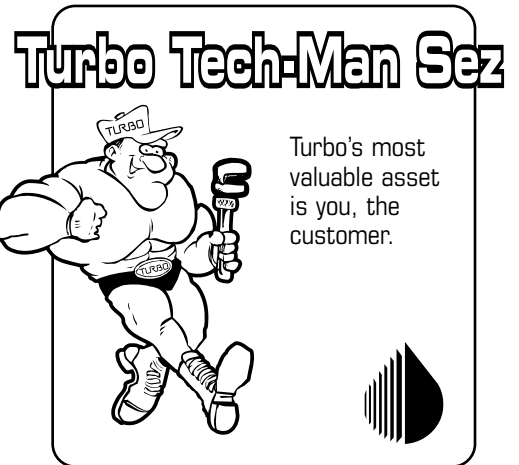

Auto Rakes

Ice Rake Assembly

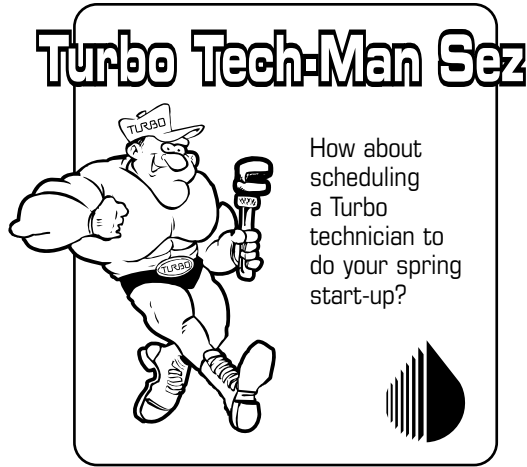

Item	Turbo Part No.	Description
1	035-1900-00	Switch Limit Furnas 54LA51
2	035-1900-1902	Switch Limit Activator Furnas 54LAP644
3	019-0100-01	Sensor Cap Prox NO or NC
4	015-0002-00	Pulley Galv Bronzed Bushed 8"
5	216-1209-30	Pulley Shaft Greaseable
6	032-3100-04	4000# Hand Winch
7	031-3100-52	Sprocket 52 Tooth with Bushing
8	031-6160-3855	Sprocket 3-7/16" Bore 38 Tooth
9	031-7160-3855	Sprocket 3-7/16" Bore 38 Tooth
10	031-1100-2240	Sprocket 2-1/2" Bore ASA 100B22
11	031-1080-1436	Sprocket 2-1/4" Bore ASA
12	031-2080-8047	Sprocket ASA80 2-15/16" Bore
13	029-0001-56	Pillow Block Bearing 3-7/16" Bore
14	029-0001-54	Pillow Block 2-15/16" Bore
15	029-0102-55	Locking Collar 3-7/16"
16	204-0003-03	Thrust Washer for Locking Collars
17	032-0501-07	Roller Chain Stainless Steel ASA 100
18	032-0504-0701	Chain Master Link ASA100 Stainless Steel
19	032-0701-10	Roller Chain C2082 Zinc Plated
20	032-1018-10	K-1 Roller Attachments C2082 Zinc Plated
21	003-5820-11	Shoulder Bolts 3/8" x 1" Zinc Plated for K-1's
22	001-0601-20	5/16"-18 Locknuts for K-1's
23	032-0803-00	Master Links C2082 Zinc Plated
24	032-0801-10	Half Links C2082 Zinc Plated
25	032-0801-11	Half Link Stainless Steel C2082
26	032-1049-11	Stainless Steel Roller Chain C2082
27	032-0601-11	Connecting Links C2082 Stainless Steel
28	032-1048-10	Stainless Steel K-1 Roller C2082
29	032-0500-06	Roller Chain Black ASA80
30	034-1800-13	Gear Motor 7-1/2 HP 230/460/3/60 59:1 Ratio
31	034-1800-14	Gear Motor 0.5 HP 230/460/3/60
32	069-1100-01	Upper Rake Pads 3" x 3"
33	069-1100-12	Lower Rake Pads 3" x 5"
34	003-2917-12	Screw 1/4"-20 x 1" for Upper Pads
35	003-2917-14	Screw 1/4"-20 x 1-1/2" for Lower Pads
36	001-0601-17	Locknuts 1/4-20 for Upper & Lower Pads
37	202-2000-33 to 36	ABCB Flite Weldments 15' Wide Rake
38	202-2000-25 to 28	Flite Weldment 20' Wide Rake (A, B, C, D)
39	216-1209-36	Electrical Counterweight
40	202-1003-2006	Adjustable Bearing Stop
41	051-0501-04	Wire Stud End 1/2" CA 3/4" Thd
42	051-0202-11	Wire Cable Stranded 1/2"
43	202-1001-0001	Rake Drive Shaft 15/20 Wide 143" long
44	202-1008-2201	Return Bend Weldment 180 Degree LH
45	202-1008-2202	Return Bend Weldment 180 Degree RH
46	202-1001-0002	Rake Idler Shaft
47	202-1001-2010	PVC Covering for Drive Shaft
48	202-1001-2011	PVC Covering for Idler Shaft
49	035-0103-0701	Relay 4 Pole 3N/O 1N/C 120 Volt
50	041-7504-04	Appelton Reel Wire 7.5 HP 460 Volt

Auto Hydraulic Door Kit Auto Rake

Auto Rakes

Item	Turbo Part No.	Description
51	075-0201-02	Hyd Gauge 0-3000 PSIG 1/4" MPT
52	075-1209-01	Hyd Manifold Red
53	075-1510-00	Hyd Power Unit MPTAC
54	216-1209-6303	Hyd Hose Assy 1/4" x 72" long
55	216-1209-6305	Hyd Hose Assy 1/2" x 72" long
56	012-0604-04	Valve Relief Hyd 1/4" NPTF 2000 PSI
57	075-0144-17	Hyd Cylinder 2-1/2"
58	216-1209-6307	Hose Assy Rake 1/2" x 22'

Back Plate Assembly with Cam Timer

Item	Turbo Part No.	Description
59	021-0308-04	Timer Ind RC4 2 Cam 120 Volt #18 Gear Rack
60	021-0300-03	Ind Timer 2 Cam Less Motor
61	021-0400-03	Timer Motor 1 RPM #2-105 120 Volt
62	021-0400-02	Replacement Micro Switch
63	035-0103-0701	Relay 4 Pole S&S 120 Volt
64	035-0820-009	Contacter 3 Pole 9 Amp 120 Volt
65	037-0701-02	10 Amp Circuit Breaker
66	035-0208-01	Load Detector 460 Volt
67	035-0208-10	Autogard Power Monitor 460 Volt
68	035-0208-11	Autogard Power Monitor 230 Volt
69	035-0203-01	Relay Time Delay Potter Brumfield
70	035-0204-00	Relay Base 8 Pin Potter Brumfield
71	021-0608-00	Trans Current 600V 50:5

Control Panel with CPU

Item	Turbo Part No.	Description
72	080-0000-30	Prog Control CPU 3.7K Ram
73	080-0000-31	Prog Control Hand Held
74	080-0000-32	Prog Control 5 Slot Rack 115/230 Volt
75	080-0000-34	Prog Control 8 Point Input Module 115 Volt
76	080-0000-36	Prog Control 8 Point Output Module 115/230 Volt
77	080-0000-39	Prog Control EEPROM Chip for CPU
78	080-0000-27	Replacement Battery for CPU
79	080-0000-43	Cable CPU to Hand Held Programmer
80	036-0005-30	Heater Strip 150W 120 Volt



Reach Turbo at:

phone **800-788-4301**

fax **800-380-3081**

e-mail **turbo1@iglobal.net**

internet **http://www.turboice.com**

Turbo Tech-Man Sez



Service or
parts — Turbo
can do it all!



Turbo CB Hydraulic Rakes & Auto Rakes Spare Parts List

Miscellaneous

Qty.	Description
10 ft.	C-2082 Chain
8	K-1 Roller Attachments
16	Shoulder Bolts for K-1 (ZP 3/8 x 1)
32	Locknuts for K-1 (ZP 5/16-18)
8	Upper Flite Pads
8	Lower Flite Pads
32	Screw Soc Hd (ZP 1/4-20 x 1)
32	Screw Soc Hd (ZP 1/4-20 x 1-1/2)
64	Locknut (ZP 1/4-20)
8	Connecting Links
6	1/2 Links
2	Bronze Bushed Sheave 6"
2	Pulley Shaft Grease Fitting
1	Hydraulic Cylinder Kit
1	Hydraulic Seal
1	Floor Screw Limit Switch Arm



Electrical

Qty.	Description
2	Starter Coil (models prior to 10-94)
2	Starter Contact Kits
2	Contact Block (Push Button)
2	Limit Switch (LS1, LS2, LS3)
1	Time Delay Relay (TD2, TD3)
1	Timer Motor MC-6 (models prior to 10-94)
1	Timer Motor MC-7 (models prior to 10-94)
1	Emergency Stop Switch (Complete)
2	Hydraulic Unload Solenoid Coil
2	Circuit Breaker 10 Amp (models prior to 10-94)
2	Fuse (models after 10-94)
1	CPU Battery
1	Input Module
1	Output Module
1	CPU



Pneumatic Systems & Miscellaneous

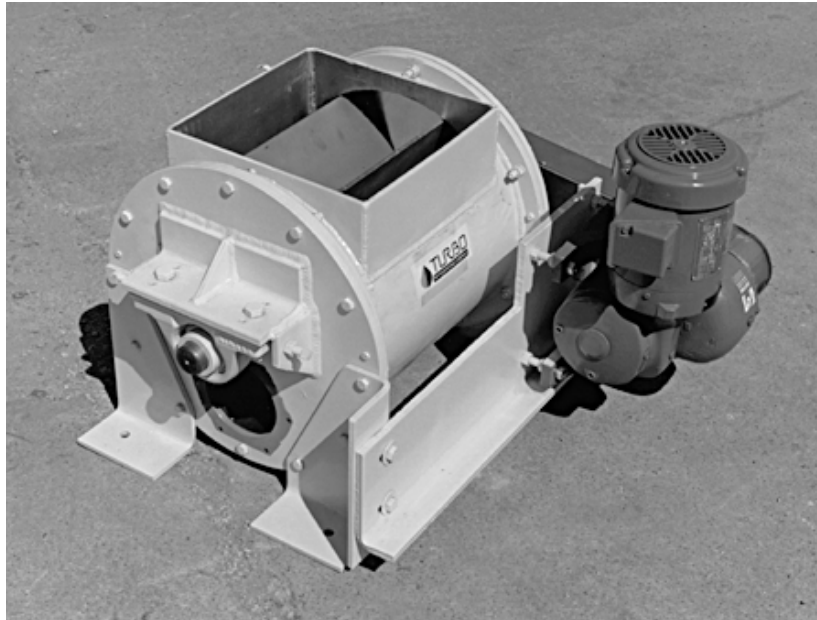

Rotary Valve

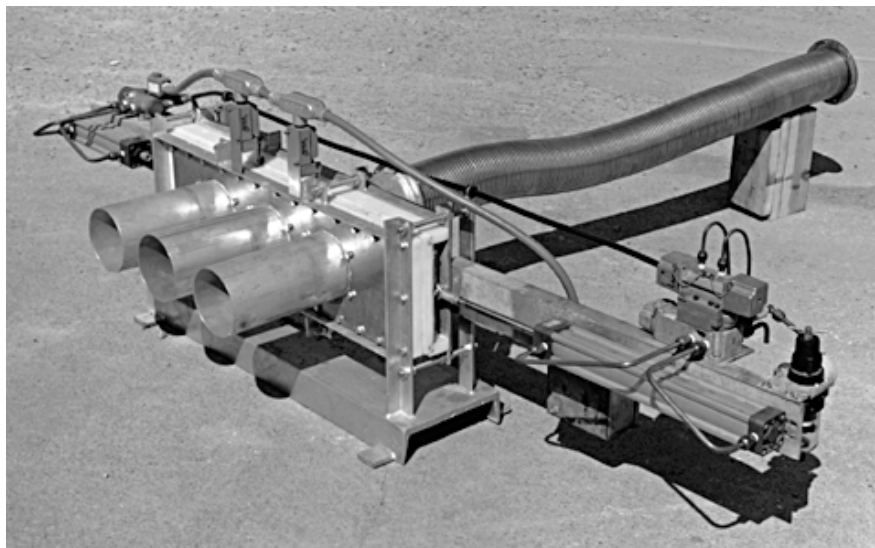

3-Way Diverter Valve